

SMART[®]

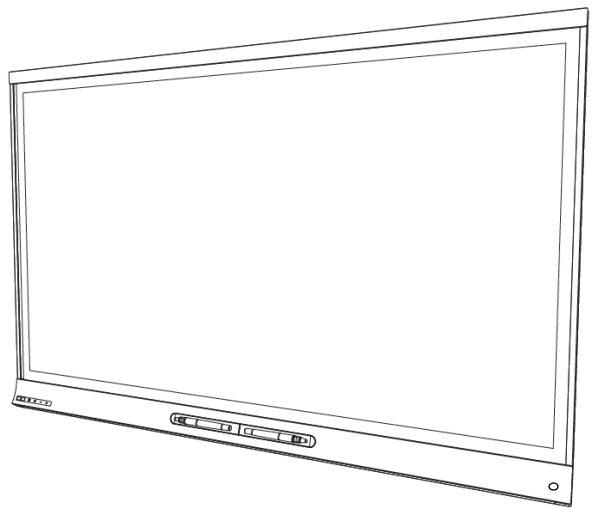

***Service Parts
Diagrams***

**For Model:
SPNL-6265P**

Service Parts Diagrams Revision History

Revision 1 - December, 2017

- New document

Revision 2 - January, 2018

- Add CAT5-XT-1100 and 1019416

Standard Warranty Terms

Base product: Three-year limited equipment warranty

First Customer Ship: October, 2017

SMART Technologies

3636 – Research Road NW

Calgary, AB T2L 1Y1

CANADA

Support +1.403.228.5940 or Toll Free 1.866.518.6791 (Canada/U.S.)

Support Fax +1.403.806.1256

www.smarttech.com/contactserviceparts www.smarttech.com

The SMART logo consists of the word "SMART" in a bold, stylized, sans-serif font. The letters are black with a white outline, and a registered trademark symbol (®) is located at the bottom right of the letter "T".

Service Parts Diagrams for the SPNL-6265P

Identifying Your Product Using the Serial Number 1
Ordering Parts 1
SPNL-6265P Parts 2

Identifying Your Product Using the Serial Number

To make sure that you have the correct service parts diagrams, you must verify the serial number of your SPNL-6265P. The serial number of the flat panel display will be located on the right underside of the bottom bezel. The serial number of the AM30/AM40 will be located on either the top or bottom of the appliance. An example of the serial number format is shown below.



Serial Number Location

Unique Serial Number

K012JW37V0078

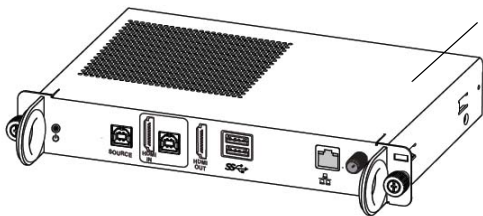

Serial Number Location

Unique Serial Number

Q022JW12C0074

OR

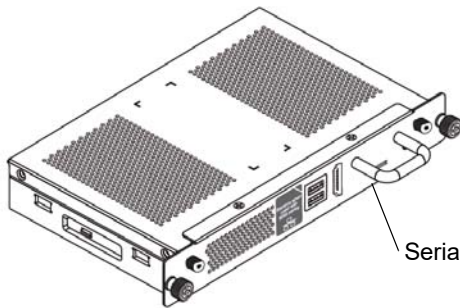

Serial Number Location

Unique Serial Number

F102JW41C00334

Ordering Parts

Customers

To order any of the parts in these service parts diagrams, contact your local reseller. To find a reseller near you, visit www.smarttech.com/where.

Dealers and Distributors

For specific technical and pricing enquiries in regards to these diagrams please contact our service parts department. Pricing is also available on-line via the SOURCE website (source.smarttech.com).

Web Form: www.smarttech.com/contactserviceparts

Phone: 1.888.42.SMART

International: +1.403.245.0333

SPNL-6265P Parts

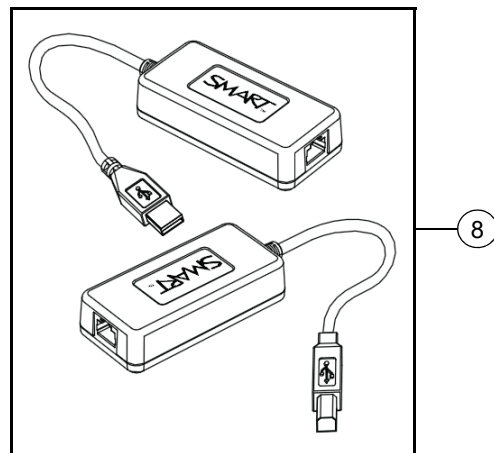
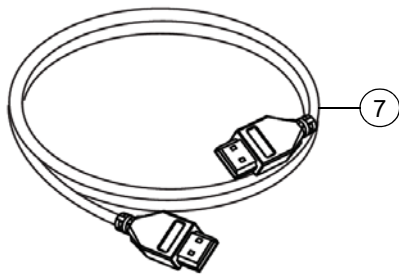
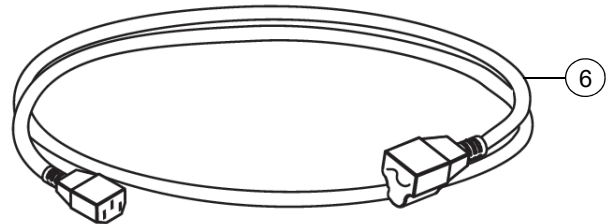
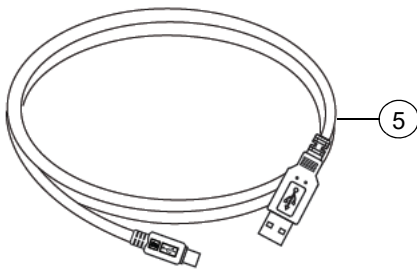
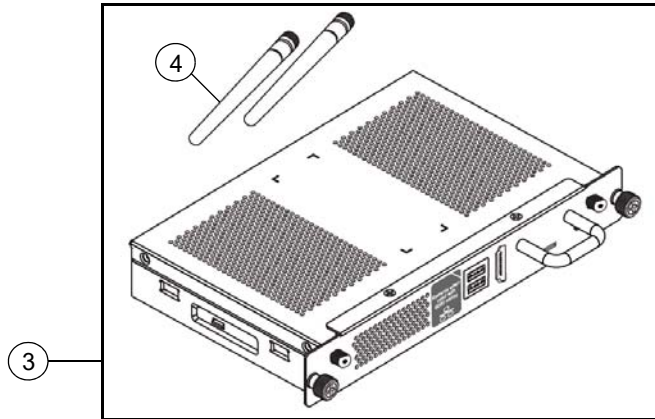
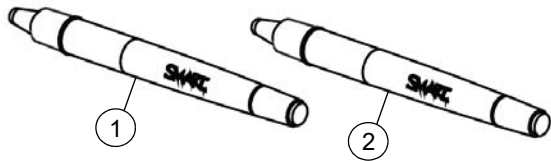

Item	Part No.	Qty	Description
1	1028647	1	Replacement Pen for SPNL-6000 Series and SBID8000-G5 Series - Red
2	1028646	1	Replacement Pen for SPNL-6000 Series and SBID8000-G5 Series - Black
3	UGK-AM40-ENT	1	iQ appliance for enterprise for SMART Board 6000 Pro and 7000 Pro series interactive displays NOTE: Includes AM40 and 2 pieces of item 4. NOTE: This is to replace AM30's that have a part number of 1028765 or AM40's that have a part number of 1029948.
4	1029824	2	Antenna
5	1028289	1	Cable, USB, A-B, 16' (5.0 m)
6	1022063	1	Cable, power, North America, 8' (2.4 m)
6	93-055	1	Cable, power, United Kingdom, 8' (2.4 m)

6	93-056	1	Cable, power, Australia, 8' (2.4 m)
6	93-054	1	Cable, power, Europe, 8' (2.4 m)
6	93-00708-20	1	Cable, power, China, 8' (2.4 m)
6	93-00654-20	1	Cable, power, Japan, 8' (2.4 m)
6	93-063	1	Cable, power, South Africa, 8' (2.4 m)
6	1018969	1	Cable, power, Singapore, 14' 9" (4.5 m)
6	1018970	1	Cable, power, India, 14' 9" (4.5 m)
6	1018971	1	Cable, power, Saudi Arabia, 14' 9" (4.5 m)
6	1018972	1	Cable, power, Brazil, 14' 9" (4.5 m)
6	1025597	1	Cable, power, Argentina, 14' 9" (4.5 m)
6	1025603	1	Cable, power, Chile and Italy, 14' 9" (4.5 m)
6	1030859	1	Cable, power, Korea, 8' (2.4 m)
7	1019416	1	Cable, HDMI male to HDMI male, 20' 8" (6.3 m)
8	CAT5-XT-1100	1	CAT 5 to USB Extender, CAT5 Cable not included
Not shown	1028372	1	Kit, packaging, SPNL-6265P